

**ZEPHYR**<sup>®</sup>  
MANUFACTURING COMPANY

**KWIK-LOK**<sup>™</sup>

TEMPORARY FASTENERS

# PLIER-OPERATED TEMPORARY FASTENERS

A diversity of plier actuated clamps for precise holding of materials.

**K** The K-type sheet holder clamp is the standard KWIK-LOK clamp. It is plier-actuated, spring-loaded and steel bodied; it is effective for most space requirements.

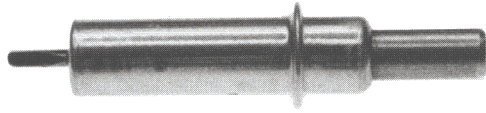

**KK** The KK-type sheet holder clamp is designed for those space requirements which prohibit the use of the standard K-type clamp. The KK-type is a miniature clamp, with a shorter overall body and special effectiveness for more confined areas.

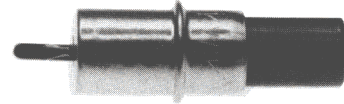

**KL/KEL** The KL and KEL-type clamps are standard K-type clamps with an extended grip range.



**KHD** The KHD clamp is designed specifically for heavier applications requiring an extended grip range not available in the standard K through KL series of sheet metal holders.

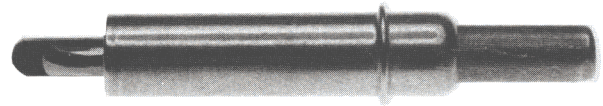

## HOW TO SELECT A PART NUMBER

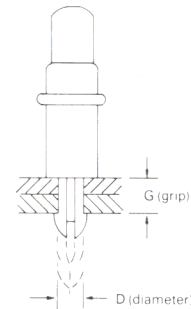
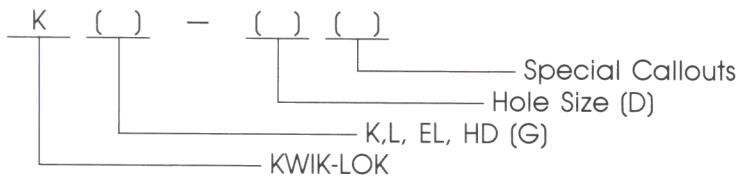

**KT** The KT is a variation of the standard K series. It has a pilot with which to index into holes through templates or outer material thicknesses.

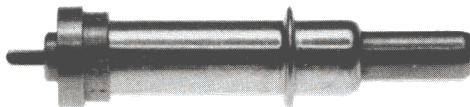

## HOW TO DETERMINE A TEMPLATE CLAMP PART NUMBER (K-KL SERIES)

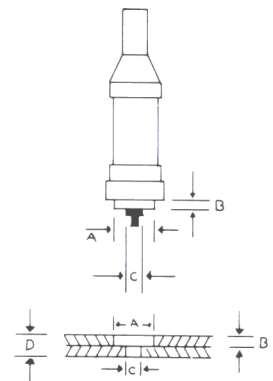
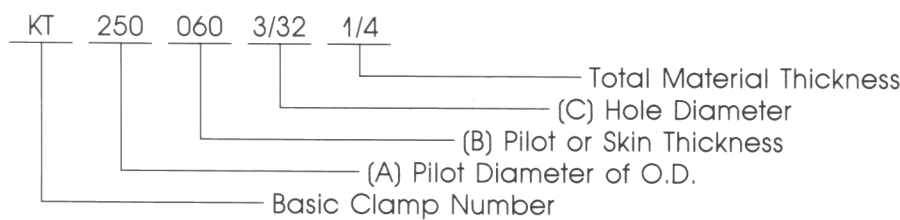

# ORDERING INFORMATION

## Plier Operated Fasteners

PART NO.	CROSS REFERENCE EQUIVALENT	COLOR CODE	G (grip)	D (diameter)	DRILL SIZE
K-1/16	M-1/16	black	0 - 1/4"	1/16"	1/16
K-3/32	M-3/32	zinc		3/32"	#40
K-1/8	M-1/8	copper		1/8"	#30
K-5/32	M-5/32	black		5/32"	#20
K-3/16	M-3/16	brass		3/16"	#10
K-7/32	M-7/32	zinc		7/32"	7/32
K-1/4	M-1/4	copper		1/4"	1/4
KK-3/32	MM-3/32	zinc	0 - 1/4"	3/32"	#40
KK-1/8	MM-1/8	copper		1/8"	#30
KK-5/32	MM-5/32	black		5/32"	#20
KK-3/16	MM-3/16	brass		3/16"	#10
KL-3/32	ML-3/32	zinc	1/4"-1/2"	3/32"	#40
KL-1/8	ML-1/8	copper		1/8"	#30
KL-5/32	ML-5/32	black		5/32"	#20
KL-3/16	ML-3/16	brass		3/16"	#10
KEL-3/32	MEL-3/32	zinc	1/2" - 3/4"	3/32"	#40
KEL-1/8	MEL-1/8	copper		1/8"	#30
KEL-5/32	MEL-5/32	black		5/32"	#20
KEL-3/16	MEL-3/16	brass		3/16"	#10
KHD-3/32	MHD-3/32	zinc	0 - 1/2"	3/32"	#40
KHD-1/8	MHD-1/8	copper		1/8"	#30
KHD-5/32	MHD-5/32	black		5/32"	#20
KHD-3/16	MHD-3/16	brass		3/16"	#10
KHD-7/32	MHD-7/32	zinc		7/32"	7/32
KHD-1/4	MHD-1/4	copper		1/4"	1/4

Special Callouts AL = Aluminum Body BO = Black Oxide

## PLIERS

### ZEPHYR PLIERS

PART NO. K-200



Specially designed for installing the K, KK, KT, KL, KEL, KHD clamps and side grips (pg 6). The KWIK-LOK Pliers are constructed of forged steel, thus resisting wear and abuse. They are nickel plated to resist corrosion as well. KWIK-LOK Pliers are compatible with all spring-loaded-types of sheet metal clamps.

**KWIK-LOK**

# POWER OPERATED & MANUAL TEMPORARY FASTENERS

Free Wheeling

## POWER - HEX NUT TYPE

- KHNS
- KHN
- KHNL
- KHNEL
- KHNK

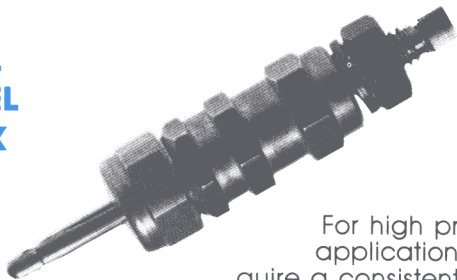

For high production applications that require a consistent, uniform clamping force. Pneumatic driven with the Power Nut Runner KNR 2000 (pg 5), this time-saving fastener is well-suited for both metallic and composite materials.

## MANUAL - WING NUT TYPE

- KWNS
- KWN
- KWNL
- KWNEL
- KWNK

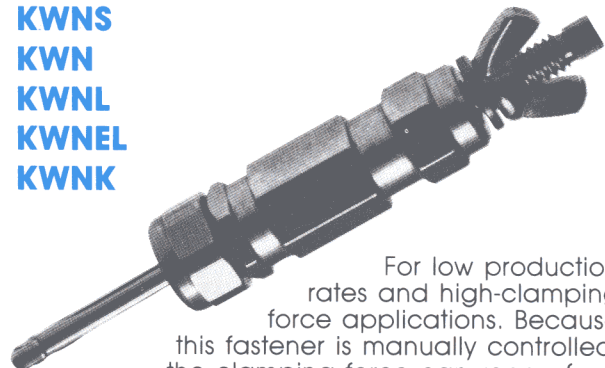

For low production rates and high-clamping force applications. Because this fastener is manually controlled, the clamping force can range from zero to 300 lbs. Well-suited for all types of metallic and composite materials.

### HOW TO SELECT PART NUMBER

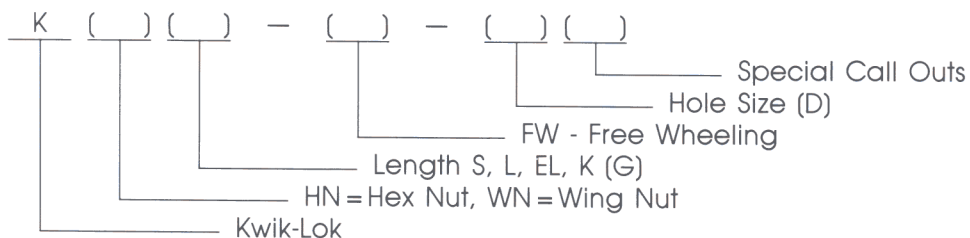
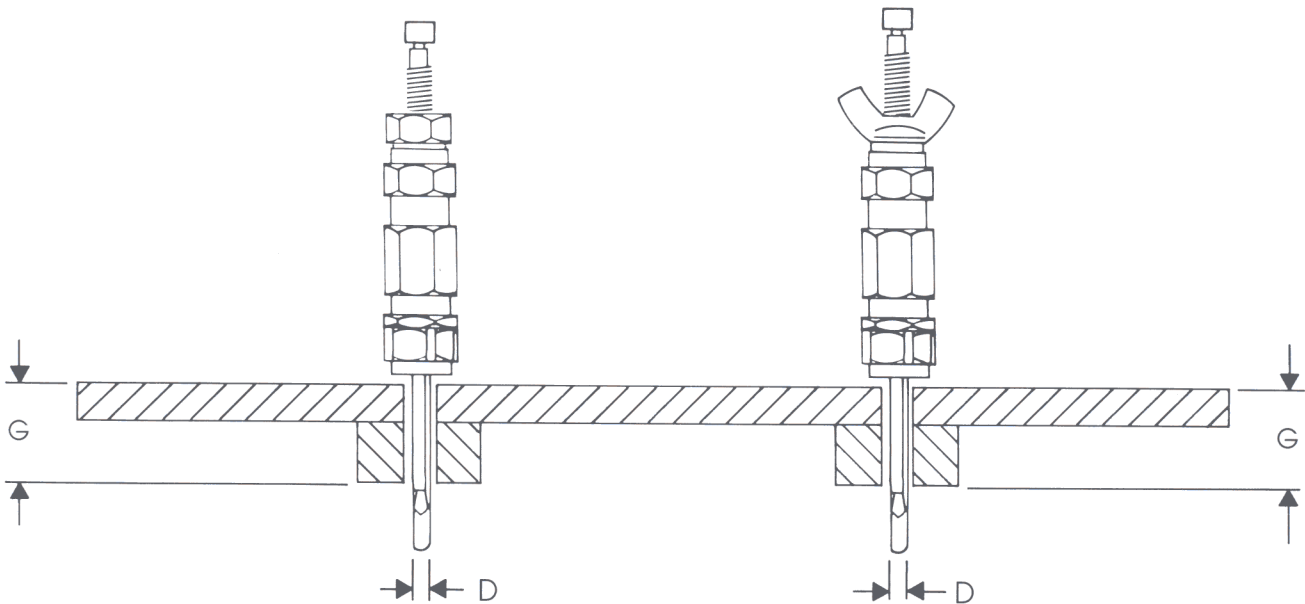

# ORDERING INFORMATION

## Power Operated & Manual Temporary Fasteners

HEX NUT PART NO.	CROSS REFERENCE EQUIVALENT	COLOR CODE	G (grip)	D (diameter)	DRILL SIZE
KHNS-FW-3/32	HNXS-SF-3/32	silver	0 - 5/16"	3/32"	#40
KHNS-FW-1/8	HNXS-SF-1/8	copper		1/8"	#30
KHNS-FW-5/32	HNXS-SF-5/32	black		5/32"	#20
KHNS-FW-3/16	HNXS-SF-3/16	brass		3/16"	#10
KHNS-FW-1/4	HNXS-SF-1/4	copper		1/4"	1/4
KHN-FW-3/32	HNX-SF-3/32	silver	0 - 1/2"	3/32"	#40
KHN-FW-1/8	HNX-SF-1/8	copper		1/8"	#30
KHN-FW-5/32	HNX-SF-5/32	black		5/32"	#20
KHN-FW-3/16	HNX-SF-3/16	brass		3/16"	#10
KHN-FW-7/32	HNX-SF-7/32	silver		7/32"	7/32
KHN-FW-1/4	HNX-SF-1/4	copper		1/4"	1/4
KHN-FW-5/16	HNX-SF-5/16	black	5/16"	5/16	
KHNL-FW-3/32	HNXL-SF-3/32	silver	0 - 1"	3/32"	#40
KHNL-FW-1/8	HNXL-SF-1/8	copper		1/8"	#30
KHNL-FW-5/32	HNXL-SF-5/32	black		5/32"	#20
KHNL-FW-3/16	HNXL-SF-3/16	brass		3/16"	#10
KHNL-FW-7/32	HNXL-SF-7/32	silver		7/32"	7/32
KHNL-FW-1/4	HNXL-SF-1/4	copper		1/4"	1/4
KHNL-FW-5/16	HNXL-SF-5/16	black	5/16"	5/16	
KHNEL-FW-3/32	HNXEL-SF-3/32	silver	1/2 - 1 1/2"	3/32"	#40
KHNEL-FW-1/8	HNXEL-SF-1/8	copper		1/8"	#30
KHNEL-FW-5/32	HNXEL-SF-5/32	black		5/32"	#20
KHNEL-FW-3/16	HNXEL-SF-3/16	brass		3/16"	#10
KHNEL-FW-1/4	HNXEL-SF-1/4	copper		1/4"	1/4
KHNEL-FW-5/16	HNXEL-SF-5/16	black		5/16"	5/16
KHNK-FW-1/8	HNXK-SF-1/8	copper	1 1/2 - 2 1/2"	1/8"	#30
KHNK-FW-5/32	HNXK-SF-5/32	black		5/32"	#20
KHNK-FW-3/16	HNXK-SF-3/16	brass		3/16"	#10
KHNK-FW-1/4	HNXK-SF-1/4	copper		1/4"	1/4
KHNK-FW-5/16	HNXK-SF-5/16	black		5/16"	5/16
WING NUT PART NO.	CROSS REFERENCE EQUIVALENT	COLOR CODE	G (grip)	D (diameter)	DRILL SIZE
KWNS-FW-3/32	WNXS-3/32	silver	0 - 5/16"	3/32"	#40
KWNS-FW-1/8	WNXS-1/8	copper		1/8"	#30
KWNS-FW-5/32	WNXS-5/32	black		5/32"	#20
KWNS-FW-3/16	WNXS-3/16	brass		3/16"	#10
KWNS-FW-1/4	WNXS-1/4	copper		1/4"	1/4
KWN-FW-3/32	WNX-3/32	silver	0 - 1/2"	3/32"	#40
KWN-FW-1/8	WNX-1/8	copper		1/8"	#30
KWN-FW-5/32	WNX-5/32	black		5/32"	#20
KWN-FW-3/16	WNX-3/16	brass		3/16"	#10
KWN-FW-7/32	WNX-7/32	silver		7/32"	7/32
KWN-FW-1/4	WNX-1/4	copper		1/4"	1/4
KWN-FW-5/16	WNX-5/16	black	5/16"	5/16	
KWNL-FW-3/32	WNXL-3/32	silver	0 - 1"	3/32"	#40
KWNL-FW-1/8	WNXL-1/8	copper		1/8"	#30
KWNL-FW-5/32	WNXL-5/32	black		5/32"	#20
KWNL-FW-3/16	WNXL-3/16	brass		3/16"	#10
KWNL-FW-7/32	WNXL-7/32	silver		7/32"	7/32
KWNL-FW-1/4	WNXL-1/4	copper		1/4"	1/4
KWNL-FW-5/16	WNXL-5/16	black	5/16"	5/16	
KWNEL-FW-3/32	WNXEL-3/32	silver	1/2 - 1 1/2"	3/32"	#40
KWNEL-FW-1/8	WNXEL-1/8	copper		1/8"	#30
KWNEL-FW-5/32	WNXEL-5/32	black		5/32"	#20
KWNEL-FW-3/16	WNXEL-3/16	brass		3/16"	#10
KWNEL-FW-1/4	WNXEL-1/4	copper		1/4"	1/4
KWNEL-FW-5/16	WNXEL-5/16	black		5/16"	5/16
KWNK-FW-1/8	WNXK-1/8	copper	1 1/2 - 2 1/2"	1/8"	#30
KWNK-FW-5/32	WNXK-5/32	black		5/32"	#20
KWNK-FW-3/16	WNXK-3/16	brass		3/16"	#10
KWNK-FW-1/4	WNXK-1/4	copper		1/4"	1/4
KWNK-FW-5/16	WNXK-5/16	black		5/16"	5/16

Special Callouts AL=Aluminum Body BO =Black Oxide AC =Aluminum Cap C = Plastic Cap



# POWER NUT RUNNER AND DRILL STOPS

## POWER NUT RUNNER

PART NO. KNR2000

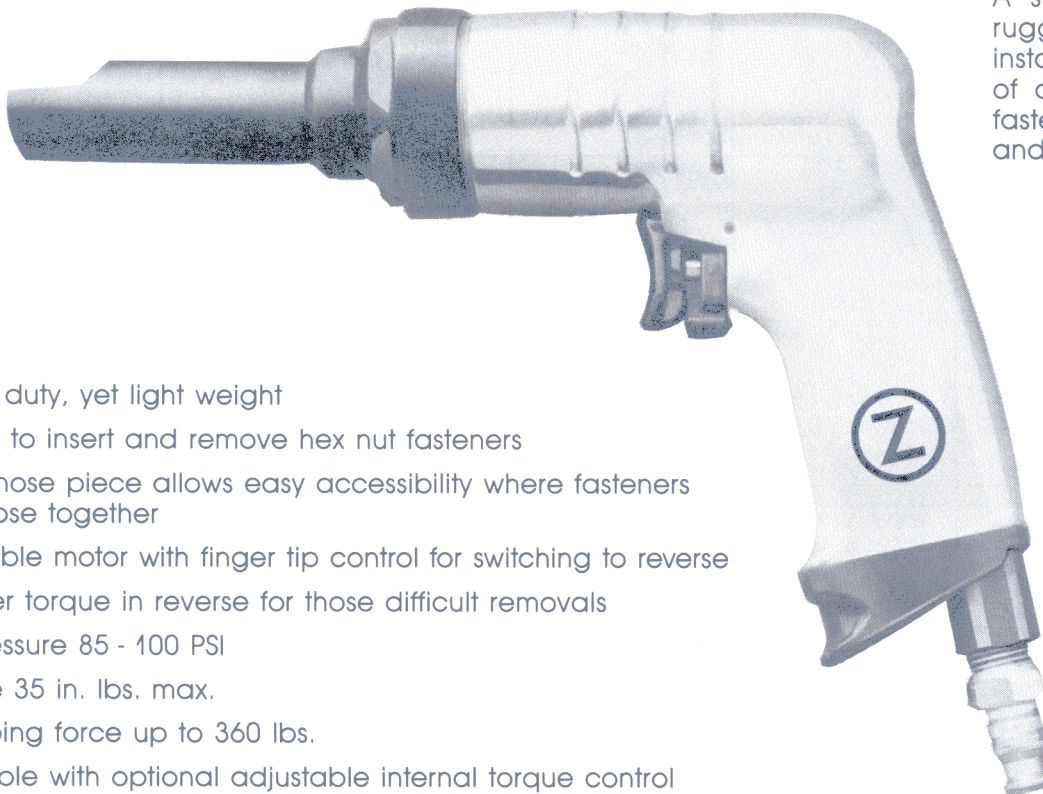

A simple to operate, rugged power tool for installation and removal of all power operated fasteners. Quiet, precise and made in the U.S.A.

- Heavy duty, yet light weight
- Simple to insert and remove hex nut fasteners
- Small nose piece allows easy accessibility where fasteners are close together
- Reversible motor with finger tip control for switching to reverse
- Greater torque in reverse for those difficult removals
- Air pressure 85 - 100 PSI
- Torque 35 in. lbs. max.
- Clamping force up to 360 lbs.
- Available with optional adjustable internal torque control

## KDS DRILL STOP

KWIK-LOK manufactures a unique multipurpose tool designed to reduce drill bit

breakage. These drill stops have a coiled spring to cushion the drill break-through. Rounded smooth face eliminates marking and prevents the chuck jaws from marring the surface.

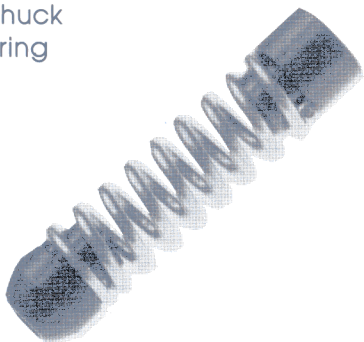

### DRILL STOP ORDERING INFORMATION

PART NO.	EQUIVALENT	COLOR CODE	DRILL SIZE
KDS 50	DS 50	black	#50
KDS 40	DS 40	zinc	#40
KDS 30	DS 30	copper	#30
KDS 28	DS 28	zinc	#28
KDS 21	DS 21	black	#21
KDS 20	DS 20	zinc	#20
KDS 12	DS 12	brass	#10
KDS 10	DS 10	brass	#10
KDS 1/4	DS 1/4	copper	1/4
KDS 5/16	DS 5/16	copper	5/16

NOTE: Other sizes available on request



# SIDE GRIPS AND KLAMPS



Plier operated edge klamps hold materials together where no holes are provided. Ideal for bonding, gluing and sealants

## SIDE GRIP ORDERING INFORMATION

PART NO.	EQUIVALENT	COLOR CODE	MATERIAL THICKNESS
KSG 1/2" x 1/2"	SG 1/2" x 1/2"	Copper	0 - 1/2"
KSG 3/4" x 1/2"	SG 3/4" x 1/2"	Brass	0 - 3/4"
KSG 1/2" x 1"	SG 1/2" x 1"	Copper	0 - 1/2"
KSG 3/4" x 1"	SG 3/4" x 1"	Brass	0 - 3/4"

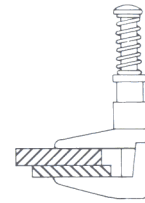
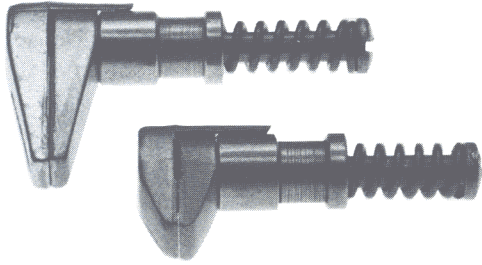

## HANDI-KLAMPS

Zephyr Handi-Klamps are a versatile tool for clamping a wide range of surfaces, shapes, thicknesses and materials.

Handi-Klamps are ideal for holding the lightest plastics, wood, sheet metal and other materials temporarily or while bonding.

## HANDI-KLAMP ORDERING INFORMATION

PART NO.	EQUIVALENT	CLAMPING CAPACITY	JAW DEPTH
K-1	W-1	0 - 5/16"	1"
K-2	W-2	0 - 5/16"	1-1/2"

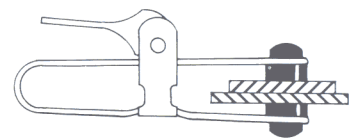

Represented By

**ZEPHYR<sup>®</sup>**  
**T O O L**

ZEPHYR MANUFACTURING CO., INC.

201 Hindry Avenue  
Inglewood, CA 90301-1519  
310-410-4907 TEL • 310-410-2912 FAX  
Zephyr@zephyrtool.com  
Http://www.zephyrtool.com



ZEPHYR<sup>®</sup> is a registered trademark of  
Zephyr Manufacturing Co., Inc.



Zephyr products are designed to be safe under proper working conditions. Be sure that you know the proper way to use a tool before working with it. We recommend the wearing of eye protection when using air hand tools or machine shop tools.

Keep your tools clean, lubricated, inspect them from time to time, and replace worn or damaged tools. The nominal cost will be more than offset by the reduction in accidents and the savings on repair.

© COPYRIGHT 1999 ZEPHYR MANUFACTURING COMPANY  
PRINTED IN THE U.S.A. 10-99-02



## Zephyr Kwik-Lok Temporary Fastener Kits



**ZKLS-1**



**ZKLS-2**



**ZKLS-3**

Zephyr offers a selection of Kwik-Lok temporary fasteners in convenient kit form. Each kit consists of Zephyr temporary fasteners, K-200 pliers, and a carrying case.

### KIT CONTENTS

**ZKLS-1:** Includes pliers, two 1/2" x 1" edge grip clamps, one each of hole clamps in sizes 3/32", 1/8", 3/16", 1/4", plastic carrying case.

**ZKLS-2:** Includes pliers, ten each of hole clamps in sizes 3/32", 1/8", 5/32", 3/16", 1/4", plastic carrying case.

**ZKLS-3:** Includes pliers, six each of side clamps in sizes 1/2" x 1", and 3/4" x 1", plastic carrying case.

K-200  
Kwik-Lok Pliers



**Zephyr's new K-200 is the only "temporary fastener" pliers hot forged from high carbon steel and heat-treated to exacting specifications. This new process offers increased life, and significantly reduces breakage. The K-200 is designed for minimum hand-reach, with new ergonomic "soft-grip" handles. The K-200 is compatible with all Cleco-style spring-loaded temporary fasteners.**

**Order Part Number: K-200**

---